



FEIN power tools with oscillating movement for limitless opportunities.

Progress through innovation.

Power tools with oscillating technology are one of the most successful developments in the richly innovative corporate history of FEIN. The principle of the oscillating drive, patented by FEIN, has been used since 1986 in the MULTIMASTER and FEIN SUPERCUTS. This marked the start of a new era for universal special tools. In addition to its unique advantages such as optimum quietness of operation without any inherent movement, the drive makes it possible to tackle tasks which previously would have entailed laborious and time-consuming manual labour. There are practically no limits to the range of potential applications. How does the oscillation work? The MULTIMASTER's and FEIN SUPERCUT's sanding plate oscillates back and forth over 20,000 times per second along an arc of just 3,2 degrees. This extremely fast, yet barely perceptible movement makes it possible to deploy a very wide range of accessories. This is a single tool for professional sawing, sanding, scraping, separating, rasping, polishing, cutting and concrete consolidation applications. The range of accessories is upgraded with new additions on an ongoing basis.

With the triangular shape of the sanding pad, the oscillation principle ensures - unlike in the case of rotating or eccentric movements - that the sanding extends right to the farthest corner and edge. And when sawing, cropped saw blades perform their work with great precision, even at places which would normally be inaccessible. The low weight and the excellent abrasive performance, even when only minimal pressure is applied, make working with this tool a pleasure. Vibrations are barely perceptible, virtually no dust is generated because the movements involved are so small. There are no recoil effects. A miracle of technology - for professionals as well as for hobby and DIY enthusiasts.

- | | |
|-----------------|------------|
| ■ MULTIMASTER | P. 178-185 |
| ■ FEIN SUPERCUT | P. 186-201 |

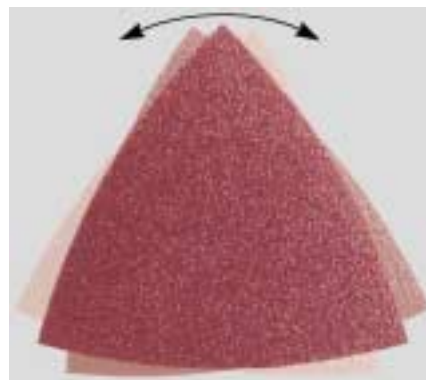

The functional principle which makes all the difference.



Oscillation for unlimited opportunities. FEIN MULTIMASTER for sanding, sawing, scraping, separating, rasping, polishing, cutting etc.



Indispensable helper in many trades: the FEIN SUPERCUT for tile-layers, glaziers, for automobile repairs, in the cladding sector etc.



Machine work, not manual labour. Profi-Sets for specific fields ensure perfect results.





MULTIMASTER START

MSx 636 II

Order Reference		7 229 26
Type		MSx 636 II START
Input	W	180
Oscillations	R.P.M.	21 000
Cable with plug	m	5
Net weight	kg	1,1
Sanding plate above corner	mm	80

Price includes:

1 sanding pad, 5 sanding sheets each grit size 60, 80, 120, 180, 1 fixed spatula, 1 E-Cut saw blade (35 mm), 1 key, tensioning screws

 21 000

 180 W



1,1 kg

AT A GLANCE

START-version for the most frequent jobs: Grinding, scraping, sawing.

- Unlimited applications due to oscillating movement.
- Very easy to handle due to its ergonomic design and light weight.
- Comprehensive accessories range available.

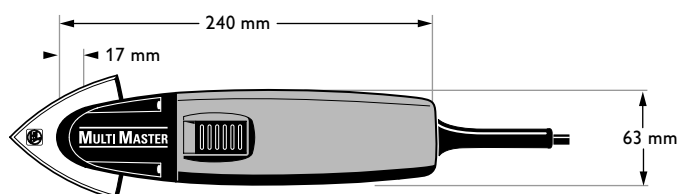



MULTIMASTER SELECT

MSxe 636 II
FEIN electronic

Order Reference		7 229 27 50
Type		MSxe 636 II SELECT
Input	W	180
Oscillations	R.P.M.	12 000-21 000
Cable with plug	m	5
Net weight	kg	1,1
Sanding plate above corner	mm	80

Price includes:

1 sanding pad, 5 sanding sheets each grit size 60, 80, 120, 180, 1 fixed spatula, 1 HSS segment saw blade, 1 E-Cut saw blade (35 mm), 1 HM segment saw blade, 1 key, tensioning screws

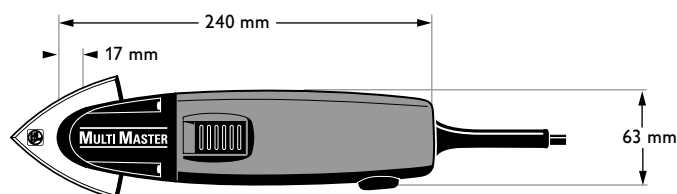

12 000-21 000

180 W 1,1 kg

AT A GLANCE

SELECT version for expanded application range.

- Professional sawing, grinding, scraping, dividing, rough machining, polishing, cutting, concrete compression, and lots more, all with a single machine.
- Unlimited applications due to oscillating movement.
- Variable electronic speed control for sensitive screwdriving applications.
- Very easy to handle due to its ergonomic design and light weight.
- Comprehensive accessories range available.

Accessories on pages 183-185.



MULTIMASTER TOP

MSxe 636 II
FEIN electronic

Order Reference	7 229 27 51	
Type	MSxe 636 II TOP	
Input	W	180
Oscillations	R.P.M.	12 000-21 000
Cable with plug	m	5
Net weight	kg	1,1
Sanding plate above corner	mm	80

Price includes:

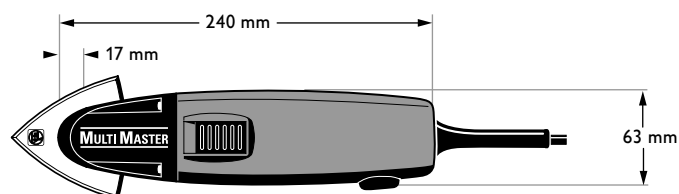

1 sanding pad, 5 sanding sheets each grit size 60, 80, 120, 180, 1 fixed spatula, 1 HSS segment saw blade, 1 E-Cut saw blade (35 mm), 1 HM segment saw blade, 1 dust suction, 1 Sanding plate with holes, with 5 sanding sheets, with holes for each of grit sizes 60, 80, 120, 180, 1 HM rasp (triangular), 1 MiniCut & diamond sharpening set each with two saw blades 10 and 20 mm and 1 diamond file, 1 metal tool case, 1 key, tensioning screws



180



 12 000-21 000

 180 W  1,1 kg

AT A GLANCE

TOP version with complete tool kit in metal tool case.

- Professional sawing, grinding, scraping, dividing, rough machining, polishing, cutting, concrete compression, and lots more, all with a single machine.
- Unlimited applications due to oscillating movement.
- Variable electronic speed control for sensitive screwdriving applications.
- Very easy to handle due to its ergonomic design and light weight.
- Comprehensive accessories range available.

Accessories on pages 183-185.



MULTIMASTER TOP EXTRA

MSxe 636 II
FEIN electronic

Order Reference	7 229 27 52	
Type	MSxe 636 II TOP EXTRA	
Input	W	180
Oscillations	R.P.M.	12 000-21 000
Cable with plug	m	5
Net weight	kg	1,1
Sanding plate above corner	mm	80

Price includes:

1 sanding pad, 5 sanding sheets each grit size 60, 80, 120, 180, 1 fixed spatula, 1 HSS segment saw blade, 1 E-Cut saw blade (35 mm), 1 HM segment saw blade, 1 dust suction, 1 Sanding plate with holes, with 5 sanding sheets, with holes for each of grit sizes 60, 80, 120, 180, 1 HM rasp (triangular), 1 MiniCut & diamond sharpening set each with two saw blades 10 and 20 mm and 1 diamond file, 1 metal tool case, 1 key, 1 FEIN "Dustex II"

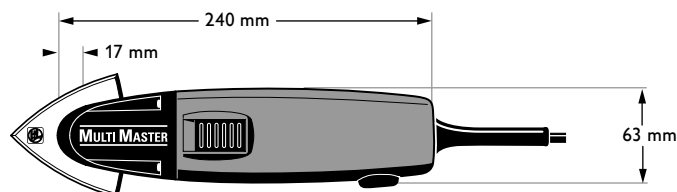

12 000-21 000

180 W 1,1 kg

AT A GLANCE

TOP version plus vacuum cleaner FEIN Dustex II

- Professional sawing, grinding, scraping, dividing, rough machining, polishing, cutting, concrete compression, and lots more, all with a single machine.
- Unlimited applications due to oscillating movement.
- Variable electronic speed control for sensitive screwdriving applications.
- Very easy to handle due to its ergonomic design and light weight.
- Comprehensive accessories range available.

Accessories on pages 183-185.



MULTIMASTER cordless

MSx 315 Storage battery

Order Reference		7 129 02
Type		MSx 315
Current/Voltages	V	9,6
Oscillations	R.P.M.	14 500
Weight with battery	kg	1,1
Sanding plate above corner	mm	80

Price includes:

1 sanding pad, 5 sanding sheets each grit size 60, 80, 120, 180,
1 HSS segment saw blade, 1 fixed spatula, 1 battery (800 mAh), 1 battery charger,
1 key, tensioning screws

14 500

1,1 kg

AT A GLANCE

Unlimited applications due to oscillating movement.

- Professional sawing, grinding, scraping, dividing, rough machining, polishing, cutting, concrete compression, and lots more, all with a single machine.
- Very easy to handle due to its ergonomic design and light weight.
- Battery operated, so you have unrestricted freedom of action.
- Identical capabilities as the mains-powered FEIN MULTIMASTER.
- Continuous operation possible with a second storage battery.
- Long-life, rapid-charge FEIN storage batteries with intelligent charging technology.
- Comprehensive accessories range available.

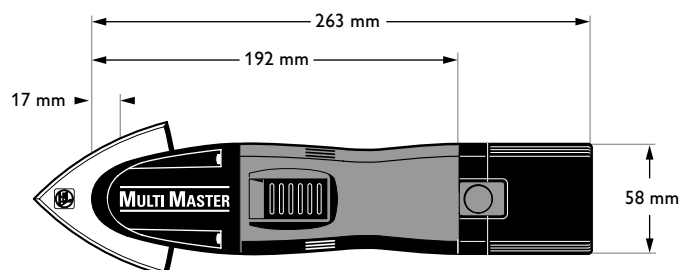



Sawing and sharpening

Set of sanding pads

For sawing wood, cement, and soft materials. Saw blades made of HSS also for plastic fibre-glass, carbon fibre reinforced plastic and sheet plates up to 1 mm thick. Cranked saw blades make it possible to work flat on the surface. The segmentation permits right-angle cuts without overcuts. E-Cut saw blades for the universal use in wood, drywall, and many plastics, or with double-row toothing for highest cutting precision. Mini-Cut for sawing tasks in places that are not easily accessible, or for small cut-outs.

Saw blades HSS



Ø mm	VE	Order Reference
63	1	6 35 02 096 02 3
63	2	6 35 02 096 01 7
80	1	6 35 02 097 02 7
80	2	6 35 02 097 01 1

Segment saw blade HSS



Ø mm	Order Reference
80	6 35 02 106 01 5

HSS Saw blade, angled



Ø mm	Order Reference
90	6 35 02 144 01 4

Segment saw blade, angled

Only for soft materials

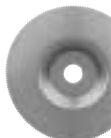

Ø mm	Order Reference
84	6 35 02 113 01 9

Depth stop ring

for saw blades Ø 63 and 80 mm without depressed centre



Order Reference 3 26 07 058 01 8

Cutting paste

Lubricating agents for working sheet metals

Order Reference 3 21 32 020 12 9

E-Cut Saw Blades

For universal use, long service life
Cutting width 35 mm



Order Reference 6 35 02 133 01 7

Cutting width 65 mm



Order Reference 6 35 02 134 01 5

with double row of toothing, for high cutting precision.
Cutting width 35 mm.

Order Reference 6 35 02 126 01 3

Cutting width 65 mm, wide shape, for higher cutting rates in the case of wooden boards and strips, as well as better positioning e.g. when trimming door frames.

Order Reference 6 35 02 127 01 7

MiniCut & Diamond sharpening set

For sawing tasks in places that are not easily accessible, or for small cut-outs. Cut-outs from as little as 10 mm wide. Exceptionally suitable for all sharpening tasks, in combination with the diamond file and the 15° clamping plate. Consists of: 1 saw blade holder, 2 saw blades (10 and 20 mm wide) for wood and other soft materials, 2 HSS saw blades (10 and 20 mm wide) for non-ferrous metals and plastic, 1 normal diamond file, 1 clamping plate (15°).



Order Reference 6 39 01 025 03 5

MiniCut saw blades

For wood and other soft materials, plunge depth 30 mm, pack of 2.

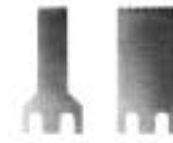

Width mm	Order Reference
10	6 35 02 132 01 3
20	6 35 02 131 01 0

HSS for non-ferrous metals and plastic, plunge depth 20 mm, pack of 2.



Width mm	Order Reference
10	6 35 02 130 01 1
20	6 35 02 129 01 9

Diamond file

Grain	Order Reference
extra fine	6 37 06 014 02 6
fine	6 37 06 013 02 8
standard	6 37 06 012 02 4

Sanding

Set of sanding pads

Pack of 2, without holes



Order Reference 6 38 06 129 02 6

Set of sanding pads "plastic backed"

With plastic backing plate to avoid scratch marks. Pack of 2.

Order Reference 6 38 06 153 02 2

Sanding sheets

Without holes, with hook and loop fastener quick-attachment, for universal use on almost all materials such as wood, metal, fibreglass reinforced plastics, plastic, paint, filler, welds, leather etc., fully synthetic-resin bonded, high sanding capacity, corundum

Grain	VE	Order Reference
36	5	6 37 17 086 04 8
40	5	6 37 17 081 04 6
60	5	6 37 17 082 04 9
80	5	6 37 17 083 04 3
100	5	6 37 17 084 04 1
120	5	6 37 17 085 04 5
150	5	6 37 17 087 04 2
180	5	6 37 17 088 04 0
220	5	6 37 17 089 04 4
240	5	6 37 17 090 04 6
280	5	6 37 17 091 04 5
320	5	6 37 17 092 04 8
400	5	6 37 17 093 04 2

Grain	VE	Order Reference
36	50	6 37 17 086 01 0
40	50	6 37 17 081 01 8
60	50	6 37 17 082 01 1
80	50	6 37 17 083 01 5
100	50	6 37 17 084 01 3
120	50	6 37 17 085 01 7
150	50	6 37 17 087 01 4
180	50	6 37 17 088 01 2
220	50	6 37 17 089 01 6
240	50	6 37 17 090 01 8
280	50	6 37 17 091 01 7
320	50	6 37 17 092 01 0
400	50	6 37 17 093 01 4

Set of sanding sheets

Consisting of: 10 sanding sheets, without holes, with hook and loop quick-attachment, grain 60, 80, 120, 180, 240.

Order Reference 6 37 17 082 03 3

Set of sanding pads, "flat"

for very narrow openings (slats of window shutters etc.). Pack of 2

Order Reference 6 38 06 142 02 9

Further accessories see pages 184/185.

Sanding pad, "Cloverleaf"

With hook and loop fastener on both sides, for use of „cloverleaf" shaped sanding sheets. Three surfaces can be worked simultaneously in a single stroke, e.g. on U-shaped profiles, in grooves, creases and folds. Pack of 2, unperforated

Order Reference 6 38 06 144 02 1

Sanding sheets "Cloverleaf"

Without holes, with hook and loop fastener quick-attachment, highly elastic, fully synthetic-resin bonded, high sanding capacity, corundum. For use in conjunction with sanding pad 6 38 06 144 02 1.



Grain	VE	Order Reference
150	5	6 37 17 129 04 9
150	50	6 37 17 129 01 1

Sanding pad "Supersoft"

Pack of 2, without holes, for special applications, these sanding pads may only be used in conjunction with the sanding sheets specified below.

Order Reference 6 38 06 141 02 6

Sanding sheets "Supersoft"

Special sanding sheets for vehicle painting works, repairs, paint runs, overspraying, wheel-rim painting, etc. Only to be used in conjunction with the sanding pad 6 38 06 141 02 6.

Without holes, with hook and loop fastener quick-attachment, fully synthetic-resin bonded, high sanding capacity, corundum, flexible



Grain	VE	Order Reference
240	50	6 37 17 126 01 5
320	50	6 37 17 127 01 9
400	50	6 37 17 128 01 7
500	50	6 37 17 179 01 6

Sanding set "Stone"

Universal application in the fields of stone processing and stone products. Consists of 5 of each sanding sheet grades, without holes, grain 40, 80, 120, 220, 320, 400, 600, 800, 1 sanding pad, without holes, with aluminium and plastic backing plate, 1 felt polishing pad.

Order Reference 6 38 06 129 06 7

Sanding sheets "Stone"

Special sanding sheets for coarse and fine sanding of natural and artificial stone. Without holes with hook and loop fastening quick-attachment, fully synthetic-resin bonded, high sanding capacity, silicon carbide, dry sanding.



Grain	VE	Order Reference
40	50	6 37 17 120 01 4
80	50	6 37 17 121 01 3
120	50	6 37 17 122 01 6
220	50	6 37 17 123 01 0
320	50	6 37 17 124 01 8
400	50	6 37 17 125 01 2
600	50	6 37 17 175 01 7
800	50	6 37 17 176 01 0

Profile grinding set

For fine grinding work in confined spaces, in grooves and on profiles. High abrasion performance, fast and simple exchanging of profiles and grinding discs. Complete set consisting of 1 holder and 6 different profiles: 1 V-form for 90° angle, 1 trapezium form for tongue-and-groove connections, 1 for straight profiles, 1 each for concave and convex forms (large), 1 each for concave and convex forms (small), as well as 5 grinding discs for 80, 120 and 180 grain respectively.



Order Reference 6 38 06 183 01 3

Sand paper

Can be used universally on almost all materials, such as wood, metal, plastic fibre-glass, plastic, enamel, filling compound, soldering joints, leather etc., high abrasion performance, packet of 25.

Grain	Order Reference
80	6 37 17 217 01 6
120	6 37 17 218 01 4
180	6 37 17 219 01 8

Sanding finger

Extra long sanding finger for use on narrow places, grooves, channels and louvers.



Height mm	VE	Order Reference
7	2	6 38 06 159 02 3
1	2	6 38 06 157 02 1

with hook and loop fastener on top and bottom side

Height mm	VE	Order Reference
2	2	6 38 06 158 02 9

Sanding sheets for sanding fingers

Without holes, with hook and loop fastener quick-attachment, fully synthetic-resin bonded, high sanding capacity, corundum, flexible



Grain	VE	Order Reference
40	20	6 37 17 184 01 2
60	20	6 37 17 185 01 6
240	20	6 37 17 192 01 9
100	20	6 37 17 187 01 3
120	20	6 37 17 188 01 1
150	20	6 37 17 189 01 5
180	20	6 37 17 190 01 7
220	20	6 37 17 191 01 6
80	20	6 37 17 186 01 9
280	20	6 37 17 193 01 3
320	20	6 37 17 194 01 1
400	20	6 37 17 195 01 5

Carbide rasp (carbide coated)

For optimum results when renovating buildings and façades, sanding tile edges, natural and artificial stone, surface sanding tile adhesive, removing graffiti on concrete and stone façades, coarse sanding wood, filler and paint. And many more applications

Triangular shape



Order Reference 6 37 31 001 01 4

Finger shape, coated on both sides



Order Reference 6 37 31 002 01 7

Sanding with dust vacuuming

Dust Extraction

Perfect dust extraction directly through the perforated sanding pad and the perforated sanding sheet. Simple retrofitting, high sanding capacity, hook and loop fastener quick-attachment. Consisting of: 2 sanding pads, perforated, with 5 perforated sanding sheets in each grade, grain 60, 80, 120, 1 suction hood with suction hose, 2 hose sleeves for hose connection Ø 27 and 32 mm as well as 2 adaptors for connection to most widely-used domestic dust extractors.

for MSx 636 and MSxe 636 II



Order Reference 9 26 02 063 02 3

Adapter hose

for connecting the dust extraction device to the most widely-used household dust extractors. The adapter hose is pushed onto the hose sleeve for hose connections of Ø 27 mm.

Type	Order Reference
thin	3 06 05 110 00 8
thick	3 06 05 109 00 6

FEIN "Dustex II"

Easy-to-use dust extractor for wet and dry use with automatic starting. The ideal dust extractor for the FEIN MULTIMASTER.



Detailed information on "dust-free sanding" and extensive accessories for the FEIN vacuum cleaner can be found in the chapter Accessories / Vacuum cleaner

Set of sanding pads

Pack of 2, with holes



Order Reference 6 38 06 136 02 9



Sanding sheets

With holes, with hook and loop quick-attachment, fully synthetic resin-bonded, high sanding capacity, corundum, „red“. For universal use with dust extraction on almost all materials such as wood, metal, fibre glass reinforced plastic, plastics, varnish, spatle, solders, leather, etc.

Grain	VE	Order Reference
36	5	6 37 17 107 04 9
40	5	6 37 17 108 04 7
60	5	6 37 17 109 04 1
80	5	6 37 17 110 04 3
100	5	6 37 17 111 04 2
120	5	6 37 17 112 04 5
150	5	6 37 17 113 04 9
180	5	6 37 17 114 04 7
220	5	6 37 17 115 04 1
240	5	6 37 17 116 04 4
280	5	6 37 17 117 04 8
320	5	6 37 17 118 04 6
400	5	6 37 17 119 04 0

Grain	VE	Order Reference
36	50	6 37 17 107 01 1
40	50	6 37 17 108 01 9
60	50	6 37 17 109 01 3
80	50	6 37 17 110 01 5
100	50	6 37 17 111 01 4
120	50	6 37 17 112 01 7
150	50	6 37 17 113 01 1
180	50	6 37 17 114 01 9
220	50	6 37 17 115 01 3
240	50	6 37 17 116 01 6
280	50	6 37 17 117 01 0
320	50	6 37 17 118 01 8
400	50	6 37 17 119 01 2

Set of sanding sheets

10 of each sanding sheets, perforated, with hook and loop quick-attachment, corundum, grain 60, 80, 120, 180, 240

Order Reference 6 37 17 109 03 5

Shaving

Fixed Scraper Blade

For removing residual carpet and tile glue, descaling, underfloor protection and damaged coatings, etc.



Order Reference 6 39 03 178 01 7

Flexible Scraper Blade

For removing layers of paint, adhesive remnants, stickers, elastic sealant in the domestic and sanitary sectors, etc., pack of 2.



Order Reference 6 39 03 165 01 3

Cutting

Carbide segment saw blade

For cutting out marble and trass concrete joints in corners, without overcutting. Working with depressed saw blade, level with the surface. Ø 63 mm.



Order Reference 6 35 02 118 01 6

Diamond-coated saw blade

For removing grout between tiled surfaces, inside bathrooms, or entryways, or kitchens. Minimum dust due to oscillating motion with no damage to adjacent tiles. Also great for making plunge cuts into plastered walls, dry wall, sheet rock, porous concrete etc. Ø 63 mm



Order Reference 6 35 02 105 01 2

Diamond-coated segment saw blade

For cutting out marble and trass concrete joints in corners, without overcutting.

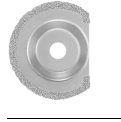

Order Reference 6 35 02 114 01 7

Cleaning block

Rhomb for cleaning of HM-tools and diamond-coated tools.



Order Reference 6 37 19 007 01 0

Cutting

Segment blade, convex

For cutting rigid materials, e.g. floor tiles made of plastic, rubber, cardboard, leather, wire meshing, looped fabric/carpets and many others.



Order Reference 6 39 03 192 01 4

Segment blade, concave

For cutting soft materials e.g. felt, leather, polystyrene and many others.



Order Reference 6 39 03 193 01 8

Bar coating renewal

Cutting blade

For cutting away polyurethane or marine glue rapidly and without effort. Also ideal for difficult areas such as cabin superstructures, bollards, gunwales or transverse joints.



Knife width mm	Order Reference
3	6 39 03 200 01 7
4	6 39 03 201 01 6
5	6 39 03 202 01 9

Polishing

Set of Felt Polishing Pads

For polishing metal parts. With the felt polishing pad set you can put a shine on all brass fittings such as winches and cleats, navigation instrument casings or parts made of steel. And you can also polish heavily-worn gelcoat layers.



Order Reference 6 38 06 140 02 7

Burnishing compounds for the respective material are available from specialist retailers.

Compressing concrete

Concrete compactor

For consolidating concrete when concreting minor foundations. With this function, trapped air can be reliably prevented.



Order Reference 6 39 01 008 01 0

General accessory

System case

empty

Order Reference 3 39 01 094 02 5

Set of clamping screws

for all FEIN MULTIMASTER accessories. Pack of 2.

Order Reference 4 30 33 087 06 5

System case

The metal case with universal fittings turns the SELECT package into a TOP version. 1 sanding pad, with holes for dust extraction, 5 sanding sheets each, with holes, each of grit size 60, 80, 120, 180. 1 dust extractor, complete with 2 hose connections for suction hose Ø 27/32 mm and 2 adaptors for standard domestic vacuum cleaners, 1 MiniCut & diamond sharpening set, 1 tungsten carbide rasp (triangular).



Order Reference 3 39 01 099 03 4

for MSx 315 accu

System case

with universal fittings: 1 storage battery (800 mAh), 1 flat sanding plate for very narrow openings, 5 each of sanding sheets grit sizes 60, 80, 120, 180, 240, 320, 3 grinding fingers with 20 sanding sheets grit size 80, 1 hard metal rasp (triangular).

Order Reference 3 39 01 099 08 1

Dust Extraction

for MSx 315

Order Reference 9 26 02 065 02 5

NiCd-Batteries

9,6 V, 1,7 Ah, 0,605 kg



Order Reference 9 26 04 030 02 8

Battery Charger

charging time approx. 40 to 100 mins depending on battery, power consumption 50 VA, charging current max. 1,7 A, weight 1,5 kg, cable length 1,2m

Order Reference 9 26 04 050 01 0

Hanging hook

for belt loop

Order Reference 3 21 25 058 00 0





■ SUPERCUT

FSN 400 E
FEIN electronic

Order Reference		7 236 28
Type		FSN 400 E
Input	W	400
Output	W	230
Oscillations	R.P.M.	11 000-22 000
Cable with plug	m	5
Net weight	kg	1,5

Price includes:

1 metal tool case, 1 sharpening stone, 1 key

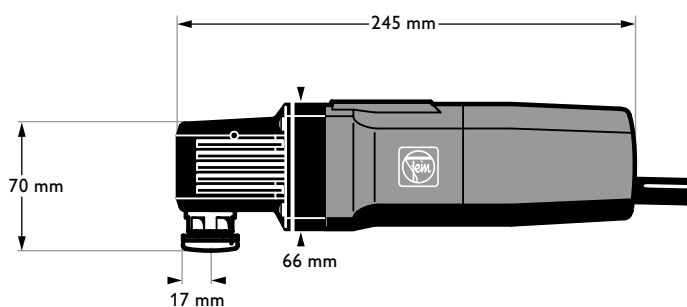

11 000-22 000

400 W 1,5 kg

AT A GLANCE

FEIN SUPERCUT with oscillating movement for universal applications.

- Infinitely variable electronic cutting frequency control.
- Powerful 400 watt motor for high cutting speeds in every application area.
- Hexagon tool clamp with positive link between machine and tool.
- Available with a comprehensive range of accessories for professional use in many industry sectors.



■ SUPERCUT

M0tx 6-24
pneumatic

Order Reference		7 536 02
Type		M0tx 6-24
Operating pressure	bar	6
Air consumption	m ³ /min	0,66
Oscillations	R.P.M.	20 000
Hose size Ø	mm	8
Net weight	kg	1,1

Price includes:

1 metal tool case, 1 key, 1 sharpening stone

20 000

1,1 kg



AT A GLANCE

Compressed air FEIN SUPERCUT with oscillating movement.

- Hexagon tool clamp with positive link between machine and tool.
- No air leaks, no oil misting in working area.
- Available with a comprehensive range of accessories for professional use in many industry sectors.

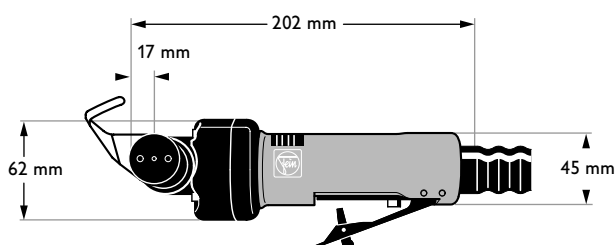

Accessories on pages 189-201.

■ The FEIN SUPERCUT Profi-Sets. With compl. accessories in tool case.

Window construction / glazing

SUPERCUT FSN 400 E in metal tool case and professional set for windows / glass.

Consisting of:

1 HSS saw-blade Ø 80 mm, 2 E-Cut saw-blades, 1 HSS-saw blade cropped Ø 100 mm, 1 adapter, 1 grinding set, 1 segment blade cropped, 1 mushroom-head blade, 1 key, 1 whetstone.

Part Number 7 236 28 51



Carpenter / interior fitters

SUPERCUT FSN 400 E in metal tool case and professional set for carpenters / interior fitters.

Consisting of:

8 E-Cut saw blades, 1 adapter, 1 grinding set, 1 key, 1 whetstone.

Part Number 7 236 28 52

Tiles / kitchens / installation

SUPERCUT FSN 400 E in metal tool case and professional set for tiles / kitchens / installation.

Consisting of:

1 diamond-coated segment saw blade, 1 HSS saw blade Ø 80 mm, 1 E-Cut saw blade, 1 adapter, 1 hard metal rasp, 1 scraper, 1 mushroom-shaped cutting blade, 1 key, 1 whetstone.

Part Number 7 236 28 53



Grout repair

SUPERCUT FSN 400 E in metal tool case and professional set for grout repair.

Consisting of:

1 hand and tool protection hoop, 2 diamond-coated cleaning blades, 1 cleaning block, 5 cutting blades straight, 1 cutting blade straight, long, 1 key, 1 whetstone.

Part Number 7 236 28 54

Automobiles / car glaziers

SUPERCUT FSN 400 E in metal tool case and professional set for automobiles / car glaziers.

Consisting of:

1 L-shaped cutting blade, 4 U-shaped cutting blades, 1 adjustable blade, 1 stopping knife, 1 scraping blade, 1 HSS saw blade Ø 80 mm, 1 key, 1 whetstone.

Part Number 7 236 28 55



FEIN SUPERCUT
accessories for vehicles/
auto glass

Remove windshields

For removing hard glued windshield without damaging the car body or the glass. A detailed overview of the knife collection can be found in the attachment.

Set for automobiles/car glaziers

Consisting of: 1 universal knife with an adjustable limit roller for all cutting jobs from the inside (Form 143, Fig.3), 4 U-shaped cutter blades for all windshield cutting from the outside (Form 076, 079, 101, Fig.4), 1 scraping knife for trimming adhesive beads (Form 129, Fig.6), 1 scraper blade, for removing underseal, 1 L-shaped cutting blade (Form 207, Fig. 8), 1 HSS saw blade Ø 80 mm.

Order Reference 6 39 03 167 25 7

Cargo-Set

For removing bonded-in vehicle windows in buses, lorries and rail transport vehicles. Consisting of 3 L-shaped cutting blades (form 207, 209, fig. 8), 2 cutting blades (form 073, fig.1), 1 cutting blade (form 081, fig. 2), 1 cutting blade (form 072, fig. 3), 1 cutting blade (form 105, fig. 6), 1 traction cable

Order Reference 6 39 03 167 32 0

Removal Device

For VW Golf III and IV, also VW Polo (as of model '95), for cutting away the rear and side windows. Consisting of: 1 sliding guide and 2 cutter blades (form 197, 113)

Order Reference 9 06 07 001 01 6

For Ford Puma, for removing the rear windscreen, consisting of 1 sliding guide and 3 cutter blades (form 204, 121, 113).

Order Reference 9 06 07 002 01 9

Cutting blades for removal devices

Pack of 2

Order Reference 6 39 03 197 01 7

Order Reference 6 39 03 204 01 1

Order Reference 6 39 03 121 01 8

Order Reference 6 39 03 113 01 6

Cutting blade

For removing bonded-in windows on heavy vehicles such as buses, lorries, special vehicles, trams, and trains.

for V-cut from outside, pack of 2

Form	Fig.	Order Reference
073	1	6 39 03 073 01 1
132	7	6 39 03 132 01 0

for separating cut from inside, pack of 2

Form	Fig.	Order Reference
072	3	6 39 03 072 01 7

for cuts from the outside, e.g. for windshields, pack of 2

Form	Fig.	Order Reference
156	4	6 39 03 156 01 7

For removing glued assembly components.
Pack of 2

Form	Fig.	Order Reference
073	1	6 39 03 073 01 1
081	2	6 39 03 081 01 3

Scraper blade

for removing underseal, pack of 1

Order Reference 6 39 03 206 01 8

Cutting blades segment shaped

For removing insulating mats, underseal and ceiling coverings. Pack of 2



Order Reference 6 39 03 190 01 2

Preparatory work

As preparation for gluing the new windscreen in place, the new adhesive beads on the windscreen flange must be trimmed to 1-2 mm thickness according to manufacturer's prescription.

Scraping knife mix

Pack of 2, for scraping off the residual adhesive bead on all popular vehicle models.

1 scraper knife, width 13 mm and 1 scraper knife, width 25 mm

Order Reference 6 39 03 113 02 2

1 scraper knife, width 12 mm and 1 scraper knife, width 25 mm

Order Reference 6 39 03 129 01 6

Scraper blade

For levelling and for piercing through the adhesive material



Order Reference 6 39 01 007 00 3

Traction cable

with handle for removing the panel from difficult places. Recommended for works on buses and locomotives.

Order Reference 9 26 02 030 01 4

Car body work

The FEIN SUPERCUT is well suited for sawing through auto body sheets up to 1.0 mm and plastic fibre-glass. Even bearing panel parts with doubled sheets can be cut easily. It is also ideal for panel repair. Since the saw blade does not rotate, injuries are practically excluded. An immersion into the material to be cut can be done at any point on the panel without any preparation. The cuts are only 0.5 mm wide, free of burrs and non-warping. There are no sparks due to the special oscillating movement of the saw blade. The cranked saw blades are highly versatile. They make flush working possible up to a plunge depth of over 30 mm (saw blade Ø 100 mm). This permits also the cutting of heavily profiled panel parts or exhaust systems.

Set of sanding pads

Pack of 2, without holes



Ø mm	Order Reference
85	6 35 02 145 01 8
100	6 35 02 137 01 6

HSS, not depressed, for universal sawing sheet metal, wood, putty and plastics.



Ø mm	VE	Order Reference
63	2	6 35 02 102 01 6
80	2	6 35 02 103 01 0

Universal saw set

with one Ø 63 mm (form 102) and one Ø 80 mm (form 103) saw blade, depth stop ring and cutting paste

Order Reference 6 35 02 102 03 8

Depth stop ring

for saw blades Ø 63 and 80 mm without depressed centre



Order Reference 3 26 07 058 01 8

Cutting paste

Lubricating agents for working sheet metals

Order Reference 3 21 32 020 12 9

FEIN SUPERCUT
accessories for tiles,
ovens, plumbing

Diamond tools

For high cutting performance and long service life with a minimum of dust. Marble, epoxy resin, and cement trass mortars can be dry cut. The original FEIN diamond tools are available as segmental knives for cutting into corners or as round saw blades for special conditions even in reinforced versions (double-coated) or with extra narrow cutting line. Diamond tools are also suited for electrical installations by slicing grooves for cables into plaster walls and aerated concrete blocks.

Tile laying set

Cut out marble and trass joints, trim door jambs, grind down adhesive and plaster, cut away elastic sealants. 1 segment saw blade (diamond-coated), 1 HSS saw blade Ø 80 mm, 1 E-Cut saw blade with twin row of Japanese teeth, length 50 mm, width 65 mm, 1 cutter blade (mushroom-shaped), 1 adapter, 1 HM rasp (triangular shape).

Order Reference 6 39 03 167 23 5

Segment blade

diamond coated, also suitable for corners and for working without overcutting. Cutting line approx. 2,2 mm, standard model for all marble, epoxy resin and trass cement joints



Order Reference 6 39 03 162 01 7

Cutting line approx. 1.2 mm, for extremely narrow marble joints. Cutting depth max. 10 mm. Not suitable for epoxy resin or trass cement joints.



Order Reference 6 39 03 196 01 3

Set of sanding pads

Diamond set, cranked, Ø 80 mm
Cutting line approx. 2.2 mm, standard design for all marble, epoxy resins and cement trass mortar



Order Reference 6 35 02 115 01 1

Cutting line approx. 1.2 mm for extremely thin marbled mortar. Not suitable for epoxy resin and cement trass mortar.

Order Reference 6 35 02 116 01 4

Cleaning block

Rhomb for cleaning of HM-tools and diamond-coated tools.



Order Reference 6 37 19 007 01 0

Carbide rasp (carbide coated)

For optimum results when renovating buildings and façades, sanding tile edges, natural and artificial stone, surface sanding tile adhesive, removing graffiti on concrete and stone façades, coarse sanding wood, filler and paint. And many more applications

Triangular shape



Order Reference 6 37 31 001 01 4

Finger shape, coated on both sides



Order Reference 6 37 31 002 01 7

Adapter

needed for mounting the accessories for rasping, sanding and polishing

Order Reference 3 01 09 128 01 8

All accessories of the MULTIMASTER with exception of the dust suction can be used.

Cutting blade

Mushroom-shaped, pack of 5, For cutting elastic silicon or acrylic connecting joints.



Order Reference 6 39 03 128 01 2

Segment form for V-cut from outside and for cuts in corners, 2-pack



Form	Fig.	Order Reference
132	7	6 39 03 132 01 0

Fixing screw

plastic laminated, to prevent scratch marks left on tiles and slabs

Order Reference 3 30 24 066 00 3

Scraper blade

for removing underseal, pack of 1

Order Reference 6 39 03 206 01 8

E-Cut saw system

Universally employable saw blades. No clearance necessary next to or behind the workpiece. Door jambs or mounted floor panelling can be sawed with ease without damaging the walls or tiles. Flooring and baseboards can be trimmed on site. Cut outs and shadow joints in drywall and for interior work are made neatly and quickly.

E-Cut Saw Blades

Standard teeth, length 78 mm. For large plunge depths. For separating window frames. Suitable for wood, gypsum plaster board and plastics.



Width mm	Teeth	Order Reference
32	16	6 35 02 123 01 8
42	22	6 35 02 124 01 6

For universal use, long service life, effective length 50 mm



Width mm	Order Reference
35	6 35 02 135 01 9
65	6 35 02 136 01 2

Double row of teeth, length 50 mm. For high cutting precision. Suitable for wood, gypsum plaster board and many plastics. Also universal cutting-out and grooving applications. The broad shape ensures higher cutting rates in the case of wooden boards and strips, as well as better positioning e.g. when trimming door frames.

Width mm	Order Reference
35	6 35 02 119 01 0
45	6 35 02 120 01 2
55	6 35 02 121 01 1
65	6 35 02 122 01 4

M-Cut Saw Blade

For cuts, cut-outs and openings in metal up to approx. 1.0 mm, Cu pipes, Al profiles, reinforced carbon fibre, plastic fibre glass. HSS, 2-pack, length 50 mm.



Cutting width mm	Order Reference
30	6 35 02 138 01 4

Depth stop

for E-Cut saw blades, for limiting the cutting depth

Order Reference 3 21 27 060 01 1

FEIN SUPERCUT accessories for windows/glass

Insulated glass renovation

Because of the special form of the segmental saw blade, 90° angles can be cut without overcut in leaves of windows and therefore causing no damage. The cranking of the tools also permits working flush to the glass plane for separation on the weather side or beneath the window bar. In nearly all cases insulated glass panes can be replaced on site. It is no problem therefore to renovate fixed window panelling. Working with the FEIN SUPERCUT provides outstanding time-savings, which is a great economical benefit. The mushroom-shaped cutting blade is used then to neatly separate the glass from the frame or for further usage of the individual panes.

Old window renovation

The accumulation of dust and dirt as well as wall damage is kept to a minimum when old window frames are taken out of the walls. Complicated additional plaster work is not necessary. When plain or composite windows need to be re-paned, the FEIN SUPERCUT does the un-cementing quick and sure. The putty seal can be cut precisely and with care. Glass splinters flying about dangerously or glass damages are practically ruled out thanks to the oscillating movement. Even putty sealing on aluminium window frames can be removed with ease. All tasks can be done on site.

Glazing set

For universal use in the glazing trade. Consisting of: 1 segment saw blade, depressed, 1 cutter blade (mushroom-shaped), 1 HSS saw blade, depressed, Ø 100 mm, 1 HSS saw blade Ø 80 mm, 1 E-cut saw blade, 78 mm length, 32 mm width, 1 E-cut saw blade 50 mm length, 35 mm width, 1 adapter, 1 sanding pad, sanding sheets grain 60, 80, 120.

Order Reference 6 39 03 167 21 3

Segment saw blade

depressed, for removing panes of insulating glass installed on a putty bed, pack of 2



Order Reference 6 39 03 166 01 6

Cutting blade

Mushroom-shaped, pack of 5, For cutting elastic silicon or acrylic connecting joints.



Order Reference 6 39 03 128 01 2

Set of sanding pads

Pack of 2, without holes



Ø mm	Order Reference
85	6 35 02 145 01 8
100	6 35 02 137 01 6

HSS, not depressed, for universal sawing sheet metal, wood, putty and plastics.



Ø	VE	Order Reference
80	2	6 35 02 103 01 0

E-Cut saw system

Universally employable saw blades. No clearance necessary next to or behind the workpiece. Door jambs or mounted floor panelling can be sawed with ease without damaging the walls or tiles. Flooring and baseboards can be trimmed on site. Cut outs and shadow joints in drywall and for interior work are made neatly and quickly.

E-Cut Saw Blades

Standard teeth, length 78 mm. For large plunge depths. For separating window frames. Suitable for wood, gypsum plaster board and plastics.



Width mm	Teeth	Order Reference
32	16	6 35 02 123 01 8
42	22	6 35 02 124 01 6

For universal use, long service life, effective length 50 mm

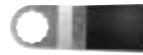

Width mm	Order Reference
35	6 35 02 135 01 9
65	6 35 02 136 01 2

Double row of teeth, length 50 mm. For high cutting precision. Suitable for wood, gypsum plaster board and many plastics. Also universal cutting-out and grooving applications. The broad shape ensures higher cutting rates in the case of wooden boards and strips, as well as better positioning e.g. when trimming door frames.

Width mm	Order Reference
35	6 35 02 119 01 0
45	6 35 02 120 01 2
55	6 35 02 121 01 1
65	6 35 02 122 01 4

M-Cut Saw Blade

For cuts, cut-outs and openings in metal up to approx. 1.0 mm, Cu pipes, Al profiles, reinforced carbon fibre, plastic fibre glass. HSS, 2-pack, length 50 mm.



Cutting width mm	Order Reference
30	6 35 02 138 01 4

Depth stop

for E-Cut saw blades, for limiting the cutting depth

Order Reference 3 21 27 060 01 1

Universal grinding set

Consisting of: 2 sanding pads with hook and loop fastener, 1 adapter with clamping screw, spring washer and wrench for mounting the sanding pad, 10 sanding sheets grain 60, 80, 120, 180, 240.

Order Reference 6 38 06 129 04 8

Sanding sheets

Without holes, with hook and loop fastener quick-attachment, for universal use on almost all materials such as wood, metal, fibreglass reinforced plastics, plastic, paint, filler, welds, leather etc., fully synthetic-resin bonded, high sanding capacity, corundum

Grain	VE	Order Reference
36	5	6 37 17 086 04 8
40	5	6 37 17 081 04 6
60	5	6 37 17 082 04 9
80	5	6 37 17 083 04 3
100	5	6 37 17 084 04 1
120	5	6 37 17 085 04 5
150	5	6 37 17 087 04 2
180	5	6 37 17 088 04 0
220	5	6 37 17 089 04 4
240	5	6 37 17 090 04 6
280	5	6 37 17 091 04 5
320	5	6 37 17 092 04 8
400	5	6 37 17 093 04 2

Grain	VE	Order Reference
36	50	6 37 17 086 01 0
40	50	6 37 17 081 01 8
60	50	6 37 17 082 01 1
80	50	6 37 17 083 01 5
100	50	6 37 17 084 01 3
120	50	6 37 17 085 01 7
150	50	6 37 17 087 01 4
180	50	6 37 17 088 01 2
220	50	6 37 17 089 01 6
240	50	6 37 17 090 01 8
280	50	6 37 17 091 01 7
320	50	6 37 17 092 01 0
400	50	6 37 17 093 01 4

Adapter

needed for mounting the accessories for rasping, sanding and polishing

Order Reference 3 01 09 128 01 8

All accessories of the MULTIMASTER with exception of the dust suction can be used.

Set of sanding pads

Pack of 2, without holes



Order Reference 6 38 06 129 02 6

Set of sanding sheets

Consisting of: 10 sanding sheets, without holes, with hook and loop quick-attachment, grain 60, 80, 120, 180, 240.

Order Reference 6 37 17 082 03 3

Set of Felt Polishing Pads

For polishing metal parts. With the felt polishing pad set you can put a shine on all brass fittings such as winches and cleats, navigation instrument casings or parts made of steel. And you can also polish heavily-worn gelcoat layers.



Order Reference 6 38 06 140 02 7

All accessories of the MULTIMASTER with exception of the dust suction can be used.

Sanding set "Stone"

Universal application in the fields of stone processing and stone products. Consists of 5 of each sanding sheet grades, without holes, grain 40, 80, 120, 220, 320, 400, 600, 800, 1 sanding pad, without holes, with aluminium and plastic backing plate, 1 felt polishing pad.

Order Reference 6 38 06 129 06 7

Sanding sheets "Stone"

Special sanding sheets for coarse and fine sanding of natural and artificial stone.

Without holes with hook and loop fastener quick-attachment, fully synthetic-resin bonded, high sanding capacity, silicon carbide, dry sanding.



Grain	VE	Order Reference
40	50	6 37 17 120 01 4
80	50	6 37 17 121 01 3
120	50	6 37 17 122 01 6
320	50	6 37 17 124 01 8
400	50	6 37 17 125 01 2
600	50	6 37 17 175 01 7
800	50	6 37 17 176 01 0

FEIN SUPERCUT
accessories for
renewing
grouting/joints

Remove mortar sealants

The oscillating movement provides a high degree of efficiency and work safety when removing plastic and elastic sealing.

Compared to other methods, the work is quite convenient without much effort. The hand and machine safety hoop is an essential accessory for all work on facades.

Cutting blade

Segment form for V-cut from outside and for cuts in corners, 2-pack

Form	Fig.	Order Reference
132	7	6 39 03 132 01 0

Further accessories see pages 192-193.

Straight, pack of 5, universal blade for almost all expansion sealants



Order Reference 6 39 03 117 01 5

Straight, long, pack of 5, for very deep joints



Order Reference 6 39 03 116 01 1

Hand and machine safety guard

Essential for renovation work involving joints in façades. Can be attached and removed quickly and easily.



Order Reference 3 18 10 242 01 6

Clean mortar flanks

The mortar flanks need to be thoroughly cleaned before the rejoining. This is done by the diamond-coated cleaning knife, which optimally prepares and roughens the surface causing hardly any dust.

Cleaning blades

Straight, diamond-coated



Order Reference 6 39 03 161 01 4

Cleaning block

Rhomb for cleaning of HM-tools and diamond-coated tools.



Order Reference 6 37 19 007 01 0

Carbide rasp (carbide coated)

For optimum results when renovating buildings and façades, sanding tile edges, natural and artificial stone, surface sanding tile adhesive, removing graffiti on concrete and stone façades, coarse sanding wood, filler and paint. And many more applications

Triangular shape



Order Reference 6 37 31 001 01 4

Finger shape, coated on both sides



Order Reference 6 37 31 002 01 7

Adapter

needed for mounting the accessories for rasping, sanding and polishing

Order Reference 3 01 09 128 01 8

All accessories of the MULTIMASTER with exception of the dust suction can be used.

FEIN SUPERCUT accessories for joiners/interior work

Carpenters Set

For universal use in joinery and interior work. Consisting of: 2 E-Cut saw blades with standard tothing (B = 32 u. 42 mm), 4 E-Cut saw blades with double row of tothing, (B = 35, 45, 55 u. 65 mm), 1 Adaptor, 1 sanding plate (triangular), 5 sanding sheets each of grit 60, 80, 120.

Order Reference 6 39 03 167 22 9

E-Cut saw system

Universally employable saw blades. No clearance necessary next to or behind the workpiece. Door jambs or mounted floor panelling can be sawed with ease without damaging the walls or tiles. Flooring and baseboards can be trimmed on site. Cut outs and shadow joints in drywall and for interior work are made neatly and quickly.

E-Cut Saw Blades

Standard teeth, length 78 mm. For large plunge depths. For separating window frames. Suitable for wood, gypsum plaster board and plastics.



Width mm	Teeth	Order Reference
32	16	6 35 02 123 01 8
42	22	6 35 02 124 01 6

For universal use, long service life, effective length 50 mm



Width mm	Order Reference
35	6 35 02 135 01 9
65	6 35 02 136 01 2

Double row of teeth, length 50 mm. For high cutting precision. Suitable for wood, gypsum plaster board and many plastics. Also universal cutting-out and grooving applications. The broad shape ensures higher cutting rates in the case of wooden boards and strips, as well as better positioning e.g. when trimming door frames.

Width mm	Order Reference
35	6 35 02 119 01 0
45	6 35 02 120 01 2
55	6 35 02 121 01 1
65	6 35 02 122 01 4

M-Cut Saw Blade

For cuts, cut-outs and openings in metal up to approx. 1.0 mm, Cu pipes, Al profiles, reinforced carbon fibre, plastic fibre glass. HSS, 2-pack, length 50 mm.



Cutting width mm	Order Reference
30	6 35 02 138 01 4

Depth stop

for E-Cut saw blades, for limiting the cutting depth

Order Reference 3 21 27 060 01 1

Adapter

needed for mounting the accessories for rasping, sanding and polishing

Order Reference 3 01 09 128 01 8

All accessories of the MULTIMASTER with exception of the dust suction can be used.

Set of sanding pads

Pack of 2, without holes



Order Reference 6 38 06 129 02 6

Sanding sheets

Without holes, with hook and loop fastener quick-attachment, for universal use on almost all materials such as wood, metal, fibreglass reinforced plastics, plastic, paint, filler, welds, leather etc., fully synthetic-resin bonded, high sanding capacity, corundum

Grain	VE	Order Reference
36	5	6 37 17 086 04 8
40	5	6 37 17 081 04 6
60	5	6 37 17 082 04 9
80	5	6 37 17 083 04 3
100	5	6 37 17 084 04 1
120	5	6 37 17 085 04 5
150	5	6 37 17 087 04 2
180	5	6 37 17 088 04 0
220	5	6 37 17 089 04 4
240	5	6 37 17 090 04 6
280	5	6 37 17 091 04 5
320	5	6 37 17 092 04 8
400	5	6 37 17 093 04 2

Grain	VE	Order Reference
36	50	6 37 17 086 01 0
40	50	6 37 17 081 01 8
60	50	6 37 17 082 01 1
80	50	6 37 17 083 01 5
100	50	6 37 17 084 01 3
120	50	6 37 17 085 01 7
150	50	6 37 17 087 01 4
180	50	6 37 17 088 01 2
220	50	6 37 17 089 01 6
240	50	6 37 17 090 01 8
280	50	6 37 17 091 01 7
320	50	6 37 17 092 01 0
400	50	6 37 17 093 01 4

Set of sanding sheets

Consisting of: 10 sanding sheets, without holes, with hook and loop quick-attachment, grain 60, 80, 120, 180, 240.

Order Reference 6 37 17 082 03 3

FEIN SUPERCUT accessories for boat builders

Cutting blade

Pack of 2



Knife width mm	Order Reference
3	6 39 03 183 01 9
4	6 39 03 184 01 7
5	6 39 03 185 01 1
6	6 39 03 186 01 4

Original FEIN Accessories

Vehicle model	Windshield	Fig.	Adjust. meas. mm	Rear window	Fig.	Adjust. meas. mm	Windshield and rear window	Fig.	Adjust. meas. mm	Side window	Fig.	Adjust. meas. mm
Alfa Romeo 145/146 (7.94→)	6 39 03 170 01 4	3	35,0/19,0	6 39 03 170 01 4	3	20,5				6 39 03 076 01 6	4	
	6 39 03 147 01 2	4		6 39 03 169 01 2	3	76				6 39 03 168 01 8	2	
Alfa Romeo 155							6 39 03 147 01 2	4				
Alfa Romeo 164	6 39 03 073 01 1	1										
	6 39 03 081 01 3	2										
	6 39 03 111 01 9	4										
Alfa Romeo 166	6 39 03 207 01 2	8										
	6 39 03 079 01 1	4										
Alfa Romeo GTV	6 39 03 147 01 2	4		6 39 03 143 01 3	3	22,0/25,0						
				6 39 03 182 01 5	3	50						
Audi 100, 200	6 39 03 079 01 2	4		6 39 03 076 01 6	4							
	6 39 03 143 01 3	3	25									
Audi 100/A6 (→12.90/→96)							6 39 03 079 01 2	4				
Audi 80 Avant (Estate)	6 39 03 114 01 4	4		6 39 03 143 01 3	3	22				6 39 03 073 01 1	1	
Audi 80 Cabrio	6 39 03 154 01 0	4										
Audi 80 Coupé	6 39 03 153 01 2	4		6 39 03 114 01 4	4							
	6 39 03 143 01 3	3	27,5									
Audi 80/90							6 39 03 114 01 4	4				
Audi A 2	6 39 03 207 01 2	8										
	6 39 03 076 01 6	4										
Audi A 3 / RS3	6 39 03 207 01 2	8										
	6 39 03 076 01 6	4										
Audi A 4 / RS4	6 39 03 207 01 2	8										
	6 39 03 076 01 6	4										
Audi A 6 Allroad (98→)	6 39 03 207 01 2	8										
	6 39 03 076 01 6	4										
Audi A 8	6 39 03 207 01 2	8					6 39 03 191 01 1	4				
	6 39 03 079 01 2	4										
Audi A 8 2003→	6 39 03 207 01 2	8										
	6 39 03 154 01 0	4										
Audi TT	6 39 03 207 01 2	8										
	6 39 03 076 01 6	4										
Austin Rover Montego	6 39 03 076 01 6	4										
	6 39 03 079 01 2	4										
Austin Rover Montego/Maestro	6 39 03 076 01 6	4		6 39 03 143 01 3	3	22						
	6 39 03 079 01 2	4										
Austin Rover 200 series							6 39 03 079 01 2	4				
Austin Rover 800 series	6 39 03 073 01 1	1					6 39 03 076 01 6	4				
	6 39 03 076 01 6	4										
BMW 3 series (E 46)	6 39 03 079 01 2	4		6 39 03 076 01 6	4							
BMW 3 series compact (E 36)							6 39 03 079 01 2	4				
BMW 3 series limo/coupé (E 36)							6 39 03 079 01 2	4				
BMW 3 series Touring (E 36)	6 39 03 079 01 2	4		6 39 03 076 01 6	4					6 39 03 143 01 3	3	16
BMW 5 series (E 39, E 34)							6 39 03 076 01 6	4				
BMW 5 series Touring (E 39, E 34)				6 39 03 079 01 2	4		6 39 03 076 01 6	4		6 39 03 143 01 3	3	
14,0/28,0												
BMW 7 series (E 38, E 32)							6 39 03 076 01 6	4		6 39 03 143 01 3	3	16
BMW X 5 (E53)	6 39 03 079 01 2	4		6 39 03 076 01 6	4					6 39 03 143 01 3	3	
				6 39 03 079 01 2	4							
BMW Z 3 Coupe	6 39 03 076 01 6	4								63903143013	3	35
BMW Z 3 Roadster	6 39 03 076 01 6	4		6 39 03 076 01 6	4							
BMW Z 8 (E52)	6 39 03 207 01 2	8										
	6 39 03 157 01 1	4										
Busses/special vehicles	6 39 03 132 01 0	7										
Busses/special vehicles with oversized adhesive beads (on request)	6 39 03 081 01 3	2										
C 25				6 39 03 103 01 7	5							
				Remove bonded roof								
Chrysler Cherokee	6 39 03 076 01 6	4					6 39 03 076 01 6	4		6 39 03 076 01 6	4	
Chrysler K Body (Le Baron, Town & Country)	6 39 03 107 01 6	4										
Chrysler PT Cruiser	6 39 03 207 01 2	8										
	6 39 03 079 01 2	4										
Chrysler Voyager	6 39 03 123 01 5	2					6 39 03 125 01 7	2				
Citroen AX	6 39 03 076 01 6	4										
	6 39 03 079 01 2	4										
Citroen BX	6 39 03 076 01 6	4		6 39 03 143 01 3	3	19				6 39 03 076 01 6	4	
				6 39 03 073 01 1	1							
Citroen BX Break				6 39 03 076 01 6	4							
				6 39 03 081 01 3	2							
Citroen Berlingo	6 39 03 207 01 2	8										
	6 39 03 079 01 2	4										
Citroen C 15	6 39 03 076 01 6	4										
	6 39 03 079 01 2	4										
Citroen CX	6 39 03 143 01 3	3	19							6 39 03 073 01 1	1	
	6 39 03 076 01 6	4								6 39 03 076 01 6	4	
Citroen Evasion	6 39 03 076 01 6	4		6 39 03 143 01 3	3	29,5				6 39 03 103 01 7	5	
	6 39 03 079 01 2	4		6 39 03 081 01 3	2					63 9 03 125 01 7	2	
Citroen Minibus				6 39 03 081 01 3	2							
				Remove bonded roof								

Vehicle model	Windshield	Fig.	Adjust. meas. mm	Rear window	Fig.	Adjust. meas. mm	Windshield and rear window	Fig.	Adjust. meas. mm	Side window	Fig.	Adjust. meas. mm
Citroen Saxo	6 39 03 076 01 6	4		6 39 03 173 01 0	2		6 39 03 146 01 8	6				
Citroen XM	6 39 03 076 01 6	4		6 39 03 124 01 3	2					6 39 03 076 01 6	4	
	6 39 03 154 01 0	4		6 39 03 125 01 7	2					6 39 03 125 01 7	2	
	6 39 03 079 01 2	4								6 39 03 124 01 3	2	
Citroen XSARA/Picasso	6 39 03 076 01 6	4		6 39 03 169 01 2	3		6 39 03 143 01 3	3				
				6 39 03 125 01 7	2							
Citroen Xantia / Picasso	6 39 03 154 01 0	4		6 39 03 125 01 7	2							
Citroen Xantia Picasso	6 39 03 207 01 2	8		6 39 03 125 01 7	2							
	6 39 03 154 01 0	4										
Citroen ZX	6 39 03 079 01 2	4		6 39 03 143 01 3	3	25				6 39 03 079 01 2	4	
Corvette	6 39 03 111 01 9	4										
DAF lorry (all)	6 39 03 209 01 4	8										
Daewoo (all)	6 39 03 207 01 2	8										
	6 39 03 079 01 2	4										
	6 36 03 101 01 0	4										
Fiat Barchetta Spider	6 39 03 207 01 2	8										
	6 39 03 079 01 2	4										
Fiat Bravo/Brava/Marea	6 39 03 207 01 2	8		6 39 03 143 01 3	3							
	6 39 03 079 01 2	4										
Fiat Coupe	6 39 03 207 01 2	8		6 39 03 143 01 3	3							
	6 39 03 079 01 2	4										
Fiat Croma	6 39 03 076 01 6	4		6 39 03 099 01 0	2		6 39 03 098 01 6	3				
Fiat Doblo	6 39 03 207 01 2	8										
	6 39 03 079 01 2	4										
Fiat Ducato	6 39 03 076 01 6	4										
	6 39 03 079 01 2	4										
Fiat Multipla	6 39 03 207 01 2	8										
	6 39 03 079 01 2	4										
Fiat Palio	6 39 03 207 01 2	8										
	6 39 03 079 01 2	4										
Fiat Punto I	6 39 03 079 01 2	4										
Fiat Punto II (99→)	6 39 03 207 01 2	8										
	6 39 03 079 01 2	4										
Fiat Seicento	6 39 03 207 01 2	8										
Fiat Stilo	6 39 03 207 01 2	8										
	6 39 03 079 01 2	4										
Fiat Tipo	6 39 03 076 01 6	4		6 39 03 143 01 3	3	27				6 39 03 072 01 7	3	
Fiat Ulysse / Scudo	6 39 03 207 01 2	8		6 39 03 143 01 3	3	29,5				6 39 03 103 01 7	5	
	6 39 03 079 01 2	4		6 39 03 081 01 3	2					6 39 03 125 01 7	2	
Fiat Ulysse II 2002→	6 39 03 207 01 2	8										
	6 39 03 194 01 6	2										
	6 39 03 111 01 9	4										
Ford Fiesta (96→)	6 39 03 076 01 6	4										
Ford Fiesta 2002→	6 39 03 207 01 2	8										
	6 39 03 079 01 2	4										
Ford Bronco II	6 39 03 079 01 2	4								6 39 03 103 01 7	5	
Ford Escort (9.90→)	6 39 03 079 01 2	4					6 39 03 076 01 6	4		6 39 03 143 01 3	3	26
"fastback"												
Ford Escort (9.90→)	6 39 03 079 01 2	4					6 39 03 076 01 6	4				
"notchback"												
Ford Escort (9.90→)	6 39 03 079 01 2	4		6 39 03 143 01 3	3	27				6 39 03 143 01 3	3	27
Ford Escort Turnier(9.90→)	6 39 03 076 01 6	4		6 39 03 157 01 1	4							
Ford Explorer	6 39 03 143 01 3	3	25,0/30,0									
	6 39 03 176 01 5	1										
	6 39 03 157 01 1	4										
Ford Focus	6 39 03 207 01 2	8										
	6 39 03 079 01 2	4										
Ford Galaxy	6 39 03 207 01 2	8					6 39 03 079 01 2	4				
	6 39 03 157 01 1	4										
Ford KA	6 39 03 114 01 4	4		6 39 03 114 01 4	4							
				6 39 03 107 01 6	4							
Ford Maverick	6 39 03 076 01 6	4		6 39 03 143 01 3	3	17				6 39 03 143 01 3	3	20
				6 39 03 157 01 1	4					6 39 03 160 01 5	2	
Ford Mondeo I "fastback"	6 39 03 157 01 1	4		6 39 03 143 01 3	3	30,0/36,0						
"fastback"	6 39 03 163 01 1	4		6 39 03 081 01 3	2							
Ford Mondeo I	6 39 03 157 01 1	4		6 39 03 076 01 6	4							
"notchback"	6 39 03 163 01 1	4										
Ford Mondeo I	6 39 03 157 01 1	4		6 39 03 143 01 3	3	22				6 39 03 143 01 3	3	28
Turnier	6 39 03 163 01 1	4		6 39 03 081 01 3	2					6 39 03 109 01 8	5	
Ford Mondeo II (2001→)	6 39 03 207 01 2	8										
	6 39 03 111 01 9	4										
Ford Orion (9.90→)							6 39 03 079 01 2	4				
Ford Probe I	6 39 03 076 01 6	4		6 39 03 143 01 3	3	31				6 39 03 143 01 3	3	28,0/21,0
	6 39 03 079 01 2	4		6 39 03 170 01 4	3	37				6 39 03 081 01 3	2	
				6 39 03 171 01 3	2							
Ford Probe II	6 39 03 076 01 6	4		6 39 03 081 01 3	2							
	6 39 03 079 01 2	4										
Ford Puma	6 39 03 076 01 6	4										

Removal device 9 06 07 002 01 9



Original FEIN Accessories

Vehicle model	Windshield	Fig.	Adjust. meas. mm	Rear window	Fig.	Adjust. meas. mm	Windshield and rear window	Fig.	Adjust. meas. mm	Side window	Fig.	Adjust. meas. mm
Ford Scorpio	6 39 03 076 01 6	4		6 39 03 143 01 3	3	22				6 39 03 143 01 3	3	17
"fastback"	6 39 03 079 01 2	4		6 39 03 123 01 5	2					6 39 03 123 01 5	2	
Ford Scorpio	6 39 03 076 01 6	4		6 39 03 143 01 3	3	22				6 39 03 143 01 3	3	17
"notchback"	6 39 03 079 01 2	4		6 39 03 123 01 5	2					6 39 03 123 01 5	2	
Ford Scorpio	6 39 03 076 01 6	4		6 39 03 098 01 6	3					6 39 03 109 01 8	5	
Turnier	6 39 03 079 01 2	4		6 39 03 109 01 8	5					6 39 03 163 01 1	4	
										6 39 03 157 01 1	4	
Ford Sierra	6 39 03 076 01 6	4		6 39 03 143 01 3	3	30,5				6 39 03 143 01 3	3	30,5
	6 39 03 103 01 7	5		6 39 03 080 01 4								
Ford Taurus	6 39 03 111 01 9	4										
	6 39 03 097 01 8	2										
	6 39 03 079 01 2	4										
Ford Transit II + III+IV	6 39 03 076 01 6	4										
Ford Windstar	6 39 03 143 01 3	3	30	6 39 03 143 01 3	3	23						
	6 39 03 157 01 1	4		6 39 03 172 01 6	5							
GMC 1500 Pick-Up Truck	6 39 03 107 01 6	4					6 39 03 081 01 3	2				
GMC Pick-Up Truck	6 39 03 097 01 8	2										
Honda (all)	6 39 03 208 01 0	8										
	6 39 03 207 01 2	8										
	6 39 03 079 01 2	4										
Hyundai (all)	6 39 03 208 01 0	8										
	6 39 03 207 01 2	8										
	6 39 03 079 01 2	4										
IVECO lorry	6 39 03 209 01 4	8										
Jaguar 300 series	6 39 03 079 01 2	4					6 39 03 095 01 1	4		6 39 03 172 01 6	5	
	6 39 03 146 01 8	6										
Jaguar XJ 6, Vanden-Plas,	6 39 03 076 01 6	4					6 39 03 103 01 7	5				
Jaguar XK 8	6 39 03 157 01 1	4					6 39 03 076 01 6	4				
Jumper	6 39 03 209 01 4	8										
Jumpy	6 39 03 207 01 2	8										
	6 39 03 079 01 2	4										
KIA / Asia (all)	6 39 03 208 01 0	8										
	6 39 03 207 01 2	8										
	6 39 03 079 01 2	4										
LKW Atego	6 39 03 209 01 4	8										
	6 39 03 079 01 2	4										
LKW Econic	6 39 03 209 01 4	8										
	6 39 03 079 01 2	4										
Lancia Dedra	6 39 03 076 01 6	4										
Lancia K	6 39 03 079 01 2	4					6 39 03 174 01 8	2				
							6 39 03 195 01 0	3	36			
Lancia Thema	6 39 03 076 01 6	4		6 39 03 099 01 0	2		6 39 03 098 01 6	3				
Lancia Y	6 39 03 207 01 2	8										
Lancia Y 10							6 39 03 073 01 1	1				
							6 39 03 076 01 6	4				
							6 39 03 076 01 6	4				
Lexus LS 400/UCF 10	6 39 03 111 01 9	4										
MINI (R50) Cooper / One	6 39 03 079 01 2	4		6 39 03 079 01 2	4					6 39 03 079 01 2	4	
	6 39 03 163 01 1			6 39 03 143 01 3	3							
Mazda (all)	6 39 03 208 01 0	8										
	6 39 03 207 01 2	8										
	6 39 03 079 01 2	4										
Mercedes M-class W163	6 39 03 208 01 0	8										
	6 39 03 209 01 4	8										
	6 35 02 103 01 0		saw blade									
	6 39 03 079 01 2	4										
	6 39 03 207 01 2	8										
	6 39 03 079 01 2	4										
Mercedes-Benz	6 39 03 079 01 2	4		6 39 03 076 01 6	4							
Mercedes-Benz 200-300 E (W124)	6 39 03 087 01 9	4		6 39 03 076 01 6	4					6 39 03 079 01 2	4	
	6 39 03 143 01 3	3	18,5	6 39 03 073 01 1	1							
Mercedes-Benz A-class	6 39 03 207 01 2	8		6 39 03 143 01 3	3		6 39 03 171 01 3	2		6 39 03 143 01 3	3	
	6 39 03 079 01 2	4										
Mercedes-Benz C-class) (W 202	6 39 03 079 01 2	4					6 39 03 076 01 6	4				
Mercedes-Benz C-class (W 203) (9/00→)	6 39 03 207 01 2	8		6 39 03 114 01 4	4							
	6 39 03 153 01 2	4										
Mercedes-Benz CL (W215)	6 39 03 207 01 2	8										
	6 39 03 079 01 2	4										
Mercedes-Benz CLK Coupe (W 208)	6 39 03 076 01 6	4					6 39 03 110 01 0	4		6 39 03 143 01 3	3	
										6 39 03 171 01 3	2	
Mercedes-Benz CLK Coupe (W 209) 2003→	6 39 03 207 01 2	8										
	6 39 03 079 01 2	4										
Mercedes-Benz E-class (W 210)	6 39 03 076 01 6	4					6 39 03 079 01 2	4				
Mercedes-Benz E-class (W 211)	6 39 03 207 01 2	8					6 39 03 079 01 2	4				
	6 39 03 079 01 2	4										
Mercedes-Benz Roadster (R129)							6 39 03 079 01 2	4		6 39 03 079 01 2	4	
Mercedes-Benz S-class (W 140)	6 39 03 143 01 3	3	22				6 39 03 114 01 4	4				

Vehicle model	Windshield	Fig.	Adjust.	Rear window	Fig.	Adjust.	Windshield and rear window	Fig.	Adjust.	Side window	Fig.	Adjust.
			meas. mm			meas. mm			meas. mm			meas. mm
Mercedes-Benz S-class (W 220) (10.98→)	6 39 03 171 01 3	2					6 39 03 076 01 6	4				
Mercedes-Benz SL (R230) 2002→	6 39 03 207 01 2	8										
Mercedes-Benz Sprinter	6 39 03 079 01 2	4										
Mercedes-Benz Sprinter	6 39 03 209 01 4	8										
Mercedes-Benz Vaneo (2001→)	6 39 03 079 01 2	4										
Mercedes-Benz Vaneo (2001→)	6 39 03 207 01 2	8										
Mercedes-Benz Vito	6 39 03 079 01 2	4										
Mercedes-Benz Vito	6 39 03 207 01 2	8										
Nissan automobiles (all)	6 39 03 079 01 2	4										
Nissan automobiles (all)	6 39 03 208 01 0	8										
Nissan automobiles (all)	6 39 03 207 01 2	8										
Nissan automobiles (all)	6 39 03 079 01 2	4										
Nissan Terrano II	6 39 03 076 01 6	4		6 39 03 143 01 3	3	18				6 39 03 143 01 3	3	20
Nissan Terrano II				6 39 03 157 01 1	4					6 39 03 160 01 5	2	
Opel Agila	6 39 03 207 01 2	8										
Opel Agila	6 39 03 079 01 2	4										
Opel Ascona				6 39 03 143 01 3	3	18,5						
Opel Astra				6 39 03 079 01 2	4		6 39 03 076 01 6	4				
Opel Astra „Caravan“ (98→)							6 39 03 163 01 1	4				
Opel Astra „fastback“ (98→)	6 39 03 163 01 1	4		6 39 03 194 01 6	2							
Opel Astra „fastback“ (98→)				6 39 03 143 01 3	3	20						
Opel Astra „fastback“ (98→)				6 39 03 169 01 2	3	76,0/71,0						
Opel Astra B	6 39 03 207 01 2	8		6 39 03 079 01 2	4		6 39 03 076 01 6	4				
Opel Astra B	6 39 03 154 01 0	4										
Opel Calibra	6 39 03 076 01 6	4		6 39 03 122 01 1	2							
Opel Calibra	6 39 03 107 01 6	4		6 39 03 123 01 5	2							
Opel Combo Tour 2002→	6 39 03 207 01 2	8										
Opel Combo Tour 2002→	6 39 03 191 01 1	4										
Opel Corsa B	6 39 03 079 01 2	4					6 39 03 076 01 6	4				
Opel Corsa C 2001→	6 39 03 207 01 2	8										
Opel Corsa C 2001→	6 39 03 079 01 2	4										
Opel Frontera	6 39 03 207 01 2	8								6 39 03 079 01 2	4	
Opel Frontera	6 39 03 079 01 2	4								6 39 03 125 01 7	2	
Opel Frontera										6 39 03 143 01 3	3	27,0/23,0
Opel Frontera										6 39 03 103 01 7	5	
Opel Kadett E „Caravan“	6 39 03 076 01 6	4		6 39 03 143 01 3	3	19						
Opel Kadett E „Caravan“	6 39 03 101 01 0	4										
Opel Kadett E "fastback"	6 39 03 076 01 6	4		6 39 03 143 01 3	3	30,5				6 39 03 103 01 7	5	
Opel Kadett E "fastback"	6 39 03 101 01 0	4										
Opel Kadett E "notchback"	6 39 03 101 01 0	4					6 39 03 076 01 6	4		6 39 03 103 01 7	5	
Opel Meriva 2003→	6 39 03 207 01 2	8										
Opel Meriva 2003→	6 39 03 191 01 1	4										
Opel Movano	6 39 03 209 01 4	8										
Opel Movano	6 39 03 079 01 2	4										
Opel Omega A	6 39 03 107 01 6	4		6 39 03 109 01 8	5							
Opel Omega A	6 39 03 108 01 4	4										
Opel Omega B „Caravan“ (Mod. 94→)	6 39 03 107 01 6	4					6 39 03 076 01 6	4				
Opel Omega B (Mod. 94→)	6 39 03 076 01 6	4										
Opel Omega B (Mod. 94→)	6 39 03 107 01 6	4										
Opel Senator	6 39 03 107 01 6	4		6 39 03 109 01 8	5							
Opel Senator	6 39 03 108 01 4	4										
Opel Senator	6 39 03 120 01 9	5										
Opel Signum 2003→	6 39 03 207 01 2	8										
Opel Signum 2003→	6 39 03 154 01 0	4										
Opel Speedster	6 39 03 207 01 2	8										
Opel Speedster	6 39 03 191 01 1	4										
Opel Tigra	6 39 03 107 01 6	4		6 39 03 123 01 5	2							
Opel Tigra	6 39 03 076 01 6	4		6 39 03 172 01 6	5							
Opel Tigra				6 39 03 173 01 0	2							
Opel Vectra "fastback"	6 39 03 076 01 6	4		6 39 03 121 01 8	1							
Opel Vectra "fastback"				6 39 03 122 01 1	2							
Opel Vectra "fastback"				6 39 03 123 01 5	2							
Opel Vectra "notchback"							6 39 03 076 01 6	4				
Opel Vectra B "fastback" (95→)	6 39 03 079 01 2	4		6 39 03 194 01 6	2							
Opel Vectra B "fastback" (95→)				6 39 03 123 01 5	2							
Opel Vectra B "notchback" (95→)	6 39 03 079 01 2	4		6 39 03 076 01 6	4							
Opel Vectra C 2002→	6 39 03 207 01 2	8										
Opel Vectra C 2002→	6 39 03 191 01 1	4										
Opel Vivaro	6 39 03 207 01 2	8										
Opel Vivaro	6 39 03 079 01 2	4										
Opel Zafira	6 39 03 207 01 2	8		6 39 03 208 01 0	8	8						
Opel Zafira	6 39 03 079 01 2	4										
Peugeot 106	6 39 03 076 01 6	4		6 39 03 143 01 3	3	17						
Peugeot 106	6 39 03 207 01 2	8	16	6 39 03 144 01 1	6							
Peugeot 106	6 39 03 146 01 8	6										
Peugeot 205				6 39 03 082 01 6	3							
Peugeot 205				6 39 03 083 01 0	4							



Original FEIN Accessories

Vehicle model	Windshield	Fig.	Adjust. meas. mm	Rear window	Fig.	Adjust. meas. mm	Windshield and rear window	Fig.	Adjust. meas. mm	Side window	Fig.	Adjust. meas. mm
Peugeot 206 2002→	6 39 03 207 01 2	8										
	6 39 03 191 01 1	4										
Peugeot 206 -2002	6 39 03 079 01 2	4		6 39 03 143 01 3	3							
				6 39 03 125 01 7	2							
Peugeot 306	6 39 03 079 01 2	4		6 39 03 143 01 3	3	28						
	6 39 03 143 01 3	3	16	6 39 03 160 01 5	2							
	6 39 03 146 01 8	6		6 39 03 144 01 1	6							
Peugeot 307	6 39 03 207 01 2	8										
	6 39 03 191 01 1	4										
Peugeot 405							6 39 03 076 01 6	4				
Peugeot 406	6 39 03 207 01 2	8		6 39 03 143 01 3	3					6 39 03 143 01 3	3	
	6 39 03 154 01 0	4		6 39 03 154 01 0	4							
Peugeot 406 Coupé				6 39 03 194 01 6	2		6 39 03 143 01 3	3				
							6 39 03 154 01 0	4				
Peugeot 605	6 39 03 154 01 0	4					6 39 03 076 01 6	4				
Peugeot 607	6 39 03 207 01 2	8										
	6 39 03 154 01 0	4										
Peugeot 806	6 39 03 076 01 6	4		6 39 03 143 01 3	3	29,5				6 39 03 103 01 7	5	
	6 39 03 079 01 2	4		6 39 03 081 01 3	2					6 39 03 125 01 7	2	
Peugeot 806	6 39 03 207 01 2	8										
	6 39 03 194 01 6	2										
	6 39 03 111 01 9	4										
Peugeot Boxer	6 39 03 209 01 4	8										
	6 39 03 079 01 2	4										
Peugeot Expert	6 39 03 207 01 2	8										
	6 39 03 079 01 2	4										
Peugeot Partner	6 39 03 207 01 2	8										
	6 39 03 079 01 2	4										
Porsche 911, Carrera (993)	6 39 03 122 01 1	2		6 39 03 118 01 3	4		6 39 03 164 01 9	5		6 39 03 103 01 7	5	
Porsche 911, Carrera 4							6 39 03 103 01 7	5		6 39 03 103 01 7	5	
Porsche 911, Carrera GT3 (996)	6 39 03 207 01 2	8										
	6 39 03 154 01 0	4										
Porsche 924/944 (2.85→)	6 39 03 072 01 7	3										
	6 39 03 114 01 4	4										
Porsche 928 S4	6 39 03 127 01 4	4										
Porsche, Boxter	6 39 03 207 01 2	8										
	6 39 03 154 01 0	4										
Renault (van) FR 1 u. PR 4										6 39 03 110 01 0	4	
Renault (van) PR 14	6 39 03 209 01 4	8								6 39 03 076 01 6	4	
	6 39 03 076 01 6	4										
Renault (van) R 312										6 39 03 110 01 0	4	
										6 39 03 108 01 4	4	
Renault (van) SC 10	6 39 03 143 01 3	3	35									
	6 39 03 209 01 4	8										
	6 39 03 073 01 1	1										
Renault (lorry) AE	6 39 03 209 01 4	8								6 39 03 076 01 6	4	
	6 39 03 207 01 2	8										
Renault (lorry) R 310	6 39 03 143 01 3	3	35									
	6 39 03 110 01 0	4										
Renault 19	6 39 03 076 01 6	4		6 39 03 079 01 2	4							
Renault 21	6 39 03 115 01 8	4		6 39 03 076 01 6	4							
	6 39 03 107 01 6	4										
	6 39 03 111 01 9	4										
Renault 25	6 39 03 079 01 2	4		6 39 03 143 01 3	3	27						
	6 39 03 076 01 6	4										
	6 39 03 073 01 1	1										
Renault Avantime	6 39 03 207 01 2	8										
	6 39 03 157 01 1	4										
Renault Clio	6 39 03 079 01 2	4										
Renault Espace I	6 39 03 207 01 2	8								6 39 03 073 01 1	1	
Renault Espace II (model 91)	6 39 03 207 01 2	8								6 39 03 097 01 8	2	
Renault Espace III (model 02)	6 39 03 207 01 2	8								6 39 03 097 01 8	2	
	6 39 03 157 01 1	4										
Renault Kangoo	6 39 03 207 01 2	8								6 39 03 104 01 5	5	
	6 39 03 079 01 2	4								6 39 03 076 01 6	4	
Renault Laguna I	6 39 03 076 01 6	4		6 39 03 143 01 3	3	30				6 39 03 143 01 3	3	
				6 39 03 081 01 3	2					6 39 03 125 01 7	2	
										6 35 02 102 01 6	saw blade	
Renault Laguna II	6 39 03 207 01 2	8										
	6 39 03 111 01 9	4										
	6 39 03 194 01 6	2										
Renault Medaillon	6 39 03 076 01 6	4										
	6 39 03 111 01 9	4										
Renault Megane I (3-door)							6 39 03 076 01 6	4		6 39 03 073 01 1	1	
Renault Megane I (5-door)	6 39 03 076 01 6	4								63903143013	3	25,0/27,0
Renault Megane II 2003→	6 39 03 207 01 2	8		6 39 03 208 01 0	8							
	6 39 03 209 01 4	8		from inside								
				6 39 03 168 01 8	2							
				from inside								

Vehicle model	Windshield	Fig.	Adjust. meas. mm	Rear window	Fig.	Adjust. meas. mm	Windshield and rear window	Fig.	Adjust. meas. mm	Side window	Fig.	Adjust. meas. mm
Renault Megane Scenic II 2003→	6 39 03 207 01 2	8										
	6 39 03 157 01 1	4										
Renault Safrane	6 39 03 107 01 6	4		6 39 03 143 01 3	3	30				6 39 03 104 01 5	5	
	6 39 03 115 01 8	4		6 39 03 160 01 5	2							
				6 39 03 125 01 7	2							
Renault Super 5	6 39 03 076 01 6	4										
	6 39 03 143 01 3	3	18,5									
	6 39 03 103 01 7	5										
	6 39 03 073 01 1	1										
Renault Twingo	6 39 03 079 01 2	4										
Renault Vel Satis	6 39 03 207 01 2	8										
	6 39 03 157 01 1	4										
Rover 214	6 39 03 143 01 3	3	24	6 39 03 195 01 0	3	42						
	6 39 03 110 01 0	4										
Rover 400				6 39 03 076 01 6	4							
Rover 416	6 39 03 076 01 6	4										
	6 39 03 195 01 0	3	33,0/37,0									
Rover 600 series	6 39 03 114 01 4	4		6 39 03 076 01 6	4							
Rover 800 series							6 39 03 076 01 6	4				
SLK Roadster (W 170)	6 39 03 207 01 2	8										
	6 39 03 110 01 0	4										
Saab 900/9-3/9-5	6 39 03 207 01 2	8										
	6 39 03 079 01 2	4										
Saab 9000	6 39 03 076 01 6	4		6 39 03 079 01 2	4							
	6 39 03 073 01 1	1										
Seat Alhambra	6 39 03 207 01 2	8					6 39 03 079 01 2	4				
	6 39 03 157 01 1	4										
Seat Arosa	6 39 03 207 01 2	8		Removal device	9 06 07 001 01 6							
	6 39 03 076 01 6	4										
Seat Cordoba	6 39 03 207 01 2	8										
	6 39 03 076 01 6	4										
Seat Ibiza/Inca	6 39 03 207 01 2	8										
	6 39 03 076 01 6	4										
Seat Leon	6 39 03 207 01 2	8										
		4										
Seat Toledo	6 39 03 207 01 2	8		6 39 03 143 01 3	3	22						
	6 39 03 079 01 2	4		6 39 03 152 01 8	3							
Skoda Fabia	6 39 03 208 01 0	8										
	6 39 03 079 01 2	4										
Skoda Fabia estate car				6 39 03 208 01 0	8							
				6 39 03 169 01 2	3							
Skoda Felicia	6 39 03 208 01 0	8		6 39 03 208 01 0	8							
	6 39 03 079 01 2	4		6 39 03 169 01 2	3							
Skoda Octavia	6 39 03 207 01 2	8		6 39 03 143 01 3	3							
	6 39 03 079 01 2	4		6 39 03 169 01 2	3							
Skoda Superb	6 39 03 207 01 2	8		6 39 03 194 01 6	2							
	6 39 03 079 01 2	4										
Smart MCC	6 39 03 207 01 2	8										
Sovereign, Daimler 3.6							6 39 03 076 01 6	4				
Subaru 1800 Travel	6 39 03 079 01 2	4										
Subaru Legacy	6 39 03 154 01 0	4										
Suzuki Pkw (all)	6 39 03 207 01 2	8										
	6 39 03 076 01 6	4										
Suzuki Vitara	6 39 03 079 01 2	4										
	6 39 03 118 01 3	4										
Toyota Carina	6 39 03 076 01 6	4										
	6 39 03 107 01 6	4										
	6 35 02 103 01 0											
Toyota Carina "fastback"	6 39 03 076 01 6	4					6 39 03 107 01 6	4				
	6 35 02 103 01 0		saw blade									
Toyota Carina "notchback"	6 39 03 107 01 6	4					6 39 03 076 01 6	4				
	6 35 02 103 01 0		saw blade									
Toyota Carina estate car (→96)	6 39 03 076 01 6	4		6 39 03 163 01 1	4							
	6 39 03 079 01 2	4										
Toyota Celica	6 39 03 104 01 5	5										
Toyota Celica T 18	6 35 02 103 01 0		saw blade				6 39 03 076 01 6	4				
Toyota Celica T 20							6 39 03 076 01 6	4				
Toyota Chaser	6 39 03 118 01 3	4										
Toyota Corolla "fastback"	6 39 03 076 01 6	4		6 39 03 143 01 3	3	22,0/34,0						
	6 39 03 079 01 2	4										
Toyota Corolla "hatchback"	6 39 03 076 01 6	4		6 39 03 143 01 3	3	25,0/29,0						
	6 39 03 079 01 2	4		6 39 03 125 01 7	2							
				6 39 03 179 01 1	2							
Toyota Corolla (9.87→)	6 39 03 118 01 3	4										
	6 39 03 110 01 0	4										
Toyota Corolla E 9 "fastback"	6 39 03 076 01 6	4		6 39 03 172 01 6	5							
	6 39 03 079 01 2	4		6 39 03 125 01 7	2							



Original FEIN Accessories

Vehicle model	Windshield	Fig.	Adjust. meas. mm	Rear window	Fig.	Adjust. meas. mm	Windshield and rear window	Fig.	Adjust. meas. mm	Side window	Fig.	Adjust. meas. mm
Toyota Corolla Levin	6 39 03 118 01 3	4										
	6 39 03 079 01 2	4										
Toyota Corolla Seca	6 39 03 118 01 3	4										
Toyota Crown										6 39 03 118 01 3	4	
Toyota automobile/van → all after 99	6 39 03 208 01 0	8										
	6 39 03 207 01 2	8										
	6 39 03 076 01 6	4										
	6 39 03 079 01 2	4										
Toyota RAV 4	6 39 03 076 01 6	4		6 39 03 079 01 2	4							
Toyota Starlet	6 39 03 118 01 3	4										
Toyota Starlet EP 8	6 39 03 108 01 4	4		6 39 03 143 01 3	3	19,0/31,0						
VW New Beetle	6 39 03 208 01 0	8										
	6 39 03 076 01 6	4										
VW van T4	6 39 03 207 01 2	8		6 39 03 143 01 3	3	18,5				6 39 03 181 01 2	2	
VW Caddy	6 39 03 207 01 2	8										
	6 39 03 076 01 6	4										
VW Corrado	6 39 03 087 01 9	4					6 39 03 098 01 6	3				
VW Golf II US version (Rabbit) and	6 39 03 079 01 2	4										
VW Golf III	6 39 03 207 01 2	8		removal device			9 06 07 001 01 6					
VW Golf IV / BORA	6 39 03 207 01 2	8		removal device			9 06 07 001 01 6					
	6 39 03 076 01 6	4										
VW Jetta US version	6 39 03 097 01 8	2										
VW LT II	6 39 03 209 01 4	8										
	6 39 03 079 01 2	4										
VW Lupo	6 39 03 207 01 2	8		removal device			90607001016					
	6 39 03 076 01 6	4										
VW Passat (4,88→)	6 39 03 076 01 6	4		6 39 03 114 01 4	4							
VW Passat (98→)	6 39 03 207 01 2	8		removal device			9 06 07 001 01 6					
	6 39 03 076 01 6	4										
VW Passat 2001	6 39 03 207 01 2	8		6 39 03 207 01 2	8					6 39 03 207 01 2	8	
light-weight armour	6 39 03 208 01 1			6 39 03 208 01 1	8					6 39 03 073 01 1	1	
	6 39 03 079 01 2	4		6 39 03 079 01 2	4							
VW Passat B 5 (96→)	6 39 03 207 01 2	8								6 39 03 198 01 5	3	
VW Passat Variant (4,88→)	6 39 03 207 01 2	8		6 39 03 143 01 3	3	22						
VW Phaeton	6 39 03 207 01 2	8										
	6 39 03 157 01 1	4										
VW Polo "hatchback" (9,90→)				6 39 03 133 01 4	3							
VW Polo →1999	6 39 03 207 01 2	8		removal device			9 06 07 001 01 6					
	6 39 03 076 01 6	4										
VW Polo 2000-	6 39 03 207 01 2	8		6 39 03 208 01 0	8							
	6 39 03 076 01 6	4		6 39 03 081 01 3	2							
VW Sharan	6 39 03 207 01 2	8					6 39 03 079 01 2	4				
	6 39 03 157 01 1	4										
VW Touareg	6 39 03 207 01 2	8										
	6 39 03 079 01 2	4										
VW Vento	6 39 03 207 01 2	8										
	6 39 03 076 01 6	4										
Volvo 360				6 39 03 143 01 3	3	19						
				6 39 03 076 01 6	4							
Volvo 440	6 39 03 076 01 6	4					63903108014	4				
Volvo 480 ES	6 39 03 076 01 6	4										
	6 39 03 108 01 4	4										
Volvo 740/760	6 39 03 079 01 2	4		6 39 03 118 01 3	4							
Volvo 740/760 Kombi	6 39 03 079 01 2	4		6 39 03 076 01 6	4							
Volvo 850/S 70	6 39 03 101 01 0	4		6 39 03 079 01 2	4		6 39 03 109 01 8	5		6 39 03 082 01 6	3	
	6 39 03 111 01 9	4								6 39 03 108 01 4	4	
	6 39 03 155 01 4	4										
Volvo 940				6 39 03 118 01 3	4							
				6 39 03 076 01 6	4							
				6 39 03 079 01 2	4							
Volvo 960	6 39 03 155 01 4	4		6 39 03 076 01 6	4		6 39 03 118 01 3	4				
				6 39 03 079 01 2	4							
Volvo V40	6 39 03 076 01 6	4					6 39 03 108 01 4	4				

Blades are supplied in packs of 2.

European Patent Nr. 0 141 035 and 0 147 427. Japan Utility Model Nr. 1756 638 and 1817 594. USA Patent Nr. 4,543,720 and 4,700,478.